

MANUAL DEL USUARIO

DEPÓSITO DE JARDÍN
CJG6X4

Gloss

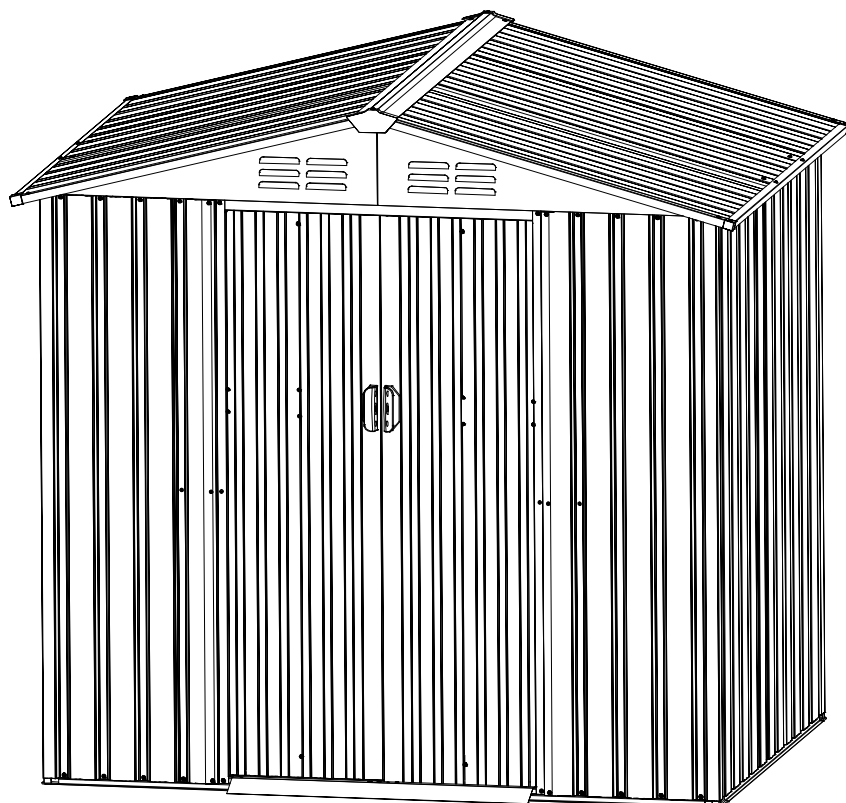

Herramientas recomendadas

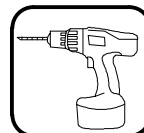
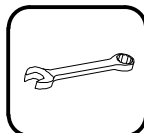
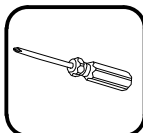

IMPORTANTE: LEA Y GUARDE PARA FUTURAS REFERENCIAS

www.bluetoolsr.com.ar

PREPARACIÓN DEL MONTAJE

Antes de comenzar la construcción, consulte los códigos de construcción locales con respecto a las bases, la ubicación y otros requisitos. Estudie y comprenda este manual del propietario ya que contiene información importante y consejos útiles para un montaje más fácil y agradable.

Instrucciones de montaje

Revise todas las instrucciones y la información apropiada antes de comenzar, asegúrese de seguir cuidadosamente la secuencia de pasos para obtener resultados exitosos.

Base de suelo:

El sitio para realizar la instalación debe estar preparado para que la base del cobertizo esté nivelada y se requiera verificar con un nivel de burbuja.

Para evitar que la humedad penetre en el cobertizo, la base se puede construir con madera tratada u hormigón. **El cobertizo no está diseñado para ser construido directamente sobre el césped.** Además, el suelo se enlodará durante los días lluviosos.

Si hace una plataforma de hormigón, es importante que las pendientes inclinen hacia los bordes para evitar la entrada de agua.

Debe esperar para que la plataforma de hormigón, concreto o cemento se seque antes de construir el cobertizo en sobre la plataforma.

Las bases también pueden ser construidas con ladrillos, bloques o montarse sobre una plataforma de hormigón.

Los ladrillos o bloques deben ser cementados sobre las bases de concreto firmes y niveladas y el marco del invernadero debe ser perforado y atornillado a la base.

Lista de Piezas y Accesorios:

Antes de comenzar, separe e identifique todas las piezas y el hardware para asegurarse de que tiene todas las piezas necesarias para su cobertizo (consulte la página de Lista de Piezas).

No intente ensamblar el cobertizo si faltan piezas, porque cualquier cobertizo parcialmente ensamblado puede resultar seriamente dañado por vientos ligeros.

La seguridad se debe enfocar en la posición No. 1.

- 1 Seleccione un día seco y tranquilo para su montaje. Se requiere trabajo en equipo (dos o más personas) durante el montaje.
- 2 Use guantes de seguridad, protección ocular y mangas largas durante el montaje para evitar lesiones; Preste atención al borde afilado de algunas partes.
- 3 Los niños y las mascotas no pueden ingresar al sitio de construcción.
- 4 Nunca concentre su peso total en el techo del edificio. Cuando utilice una escalera de mano, asegúrese de que sea segura.

Cuidado y Mantenimiento

- 1 Mantenga limpio el cobertizo con un paño suave, use agua si es necesario.
- 2 Mantenga los rieles de las puertas libres de suciedad y otras cosas que eviten que se deslicen fácilmente.
- 3 Limpie la nieve con las herramientas necesarias para asegurarse de que sea seguro ingresar; Las fuertes nevadas pueden provocar un colapso, por favor asegúrese de seguridad antes de entrar.
- 4 El cobertizo no está hecho para vivir sino para almacenar cosas.

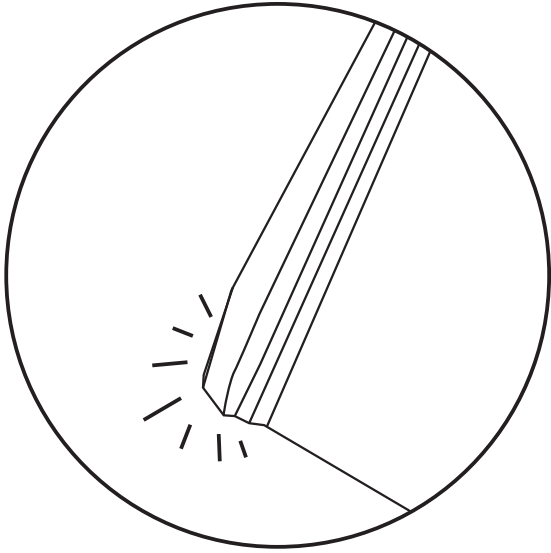

ES_NOTA: Si hay una ligera flexión en las esquinas

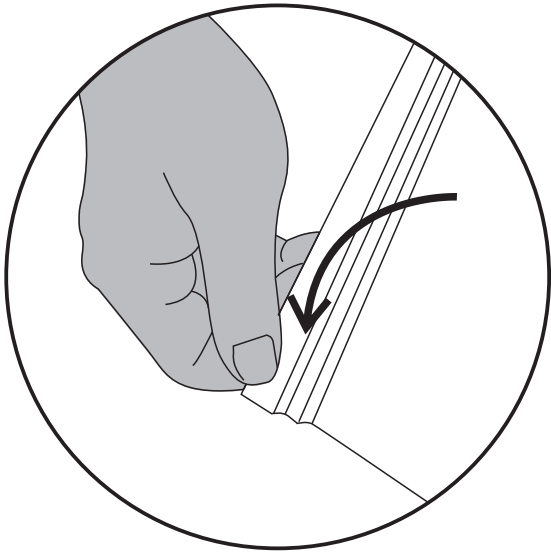



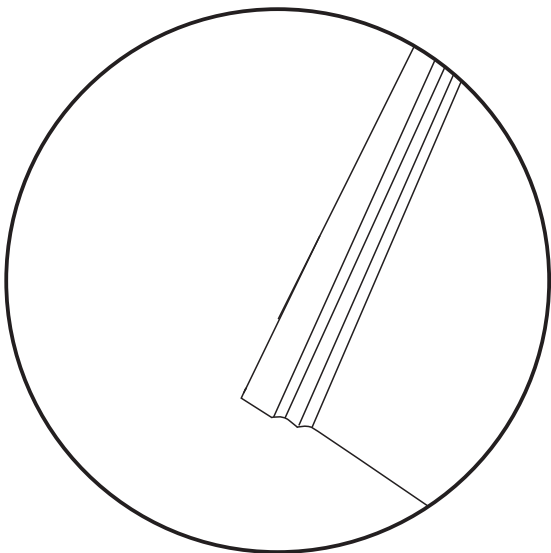





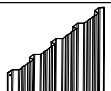
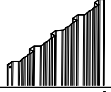
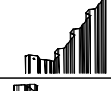
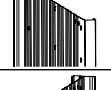

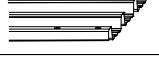





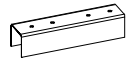
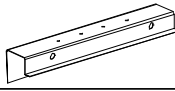









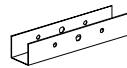
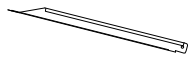

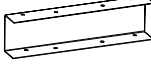
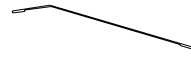

ES_1. Por favor, use guantes y estire las esquinas ligeramente hasta que queden planas

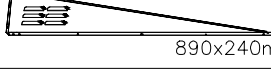
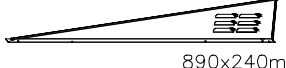
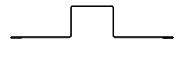

ES_2. Entonces las hojas serán normales y no hay ninguna influencia sobre el ensamblaje

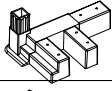
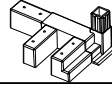
Carton:1/1

NO.	PART.	Qty.
W5	 1560mm	6
W6	 1560mm	2
W7	 1560mm	4
M1	 1560x430mm	1
M2	 1560x430mm	1
W12	 996mm	8
1L	 861mm	1
1R	 861mm	1
2L	 1043mm	1
2R	 1043mm	1
3L	 808mm	1
3R	 914mm	1
4F	 120mm	2
4B	 200mm	1
5	 1515mm	4
6L	 869mm	1
6R	 869mm	1
7	 1102mm	2
8L	 869mm	1
8R	 869mm	1

9	 1186mm	1
10	 100mm	1
10F	 350mm	2
11L	 240mm	2
11R	 240mm	2
12	 120mm	1
15	 815mm	2
17L	 1560mm	1
17R	 1560mm	1
18	 1296mm	1
19	 1296mm	2
20	 996mm	4
21L	 890x240mm	2
21R	 890x240mm	2
22	 425mm	6
23	 875mm	1
A	 1	1
B	 1	1
C	 2	2
D	 1	1
E	 1	1
F	 2	2

NR.	PART	MM	QTY
UNDER			
1L		861	1
1R		861	1
2L		1043	1
2R		1043	1
3L		808	1
3R		914	1
4F		120	2
4B		200	1
15		815	2
MIDDLE			
W5		1560	6
W6		1560	2
W7		1560	4
5		1515	4
7		1102	2
8L		869	1
8R		869	1
6L		869	1
6R		869	1
10		100	1
12		120	1
23		875	1
TOP1			
9		1186	1
10F		350	2
11L		240	2
11R		240	2
19		1296	2
20		996	4
21L		890*240	2
21R		890*240	2

NR.	PART	MM	QTY
TOP2			
W12		996	8
18		1296	1
DOOR			
17L		1560	1
17R		1560	1
M1		1560x430	1
M2		1560x430	1
22		425	6
ANNEX			
A			1
B			1
C			2
D			1
E			1
F			2
F1			4
F2			2
F3			4
F4			4
F5			2
F7			235
F8			36
S4			240
S6			61
S6a			4
S7			65
S8			12
S9			4

1L		1
1R		1
4F		2
S4		4

01

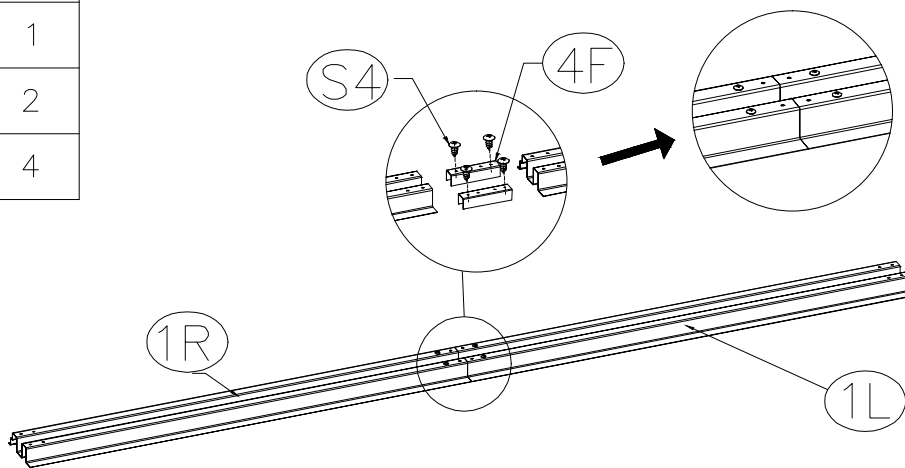

15		2
S4		8



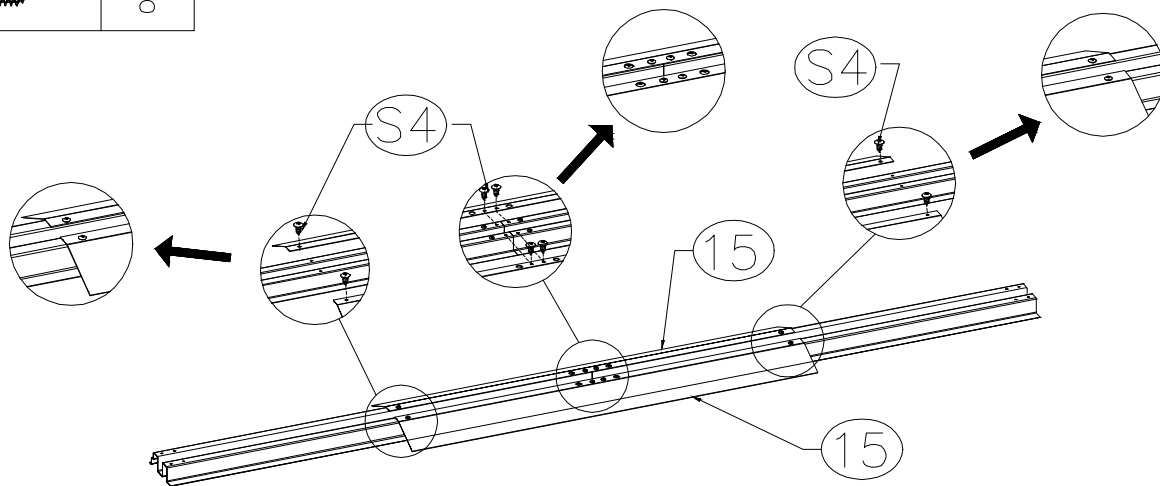



02

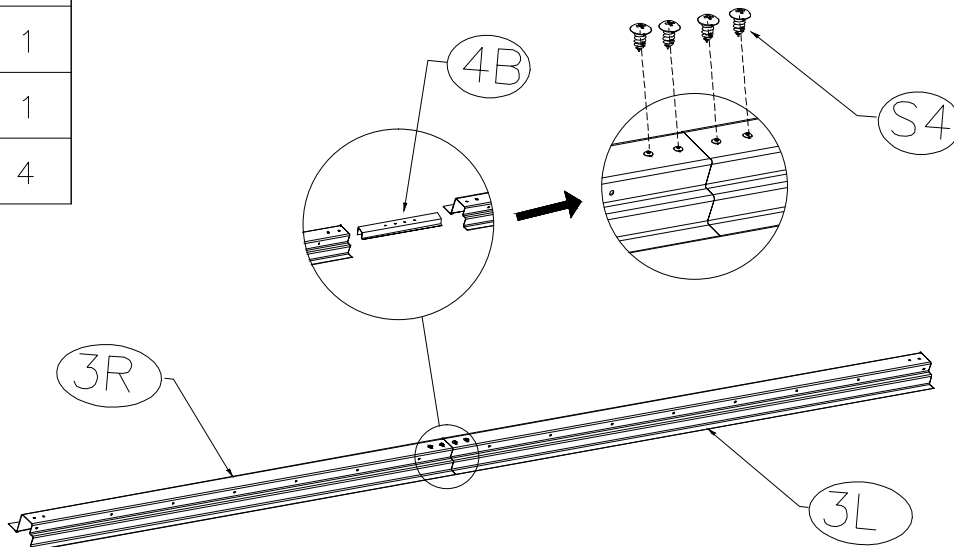

3L		1
3R		1
4B		1
S4		4





03

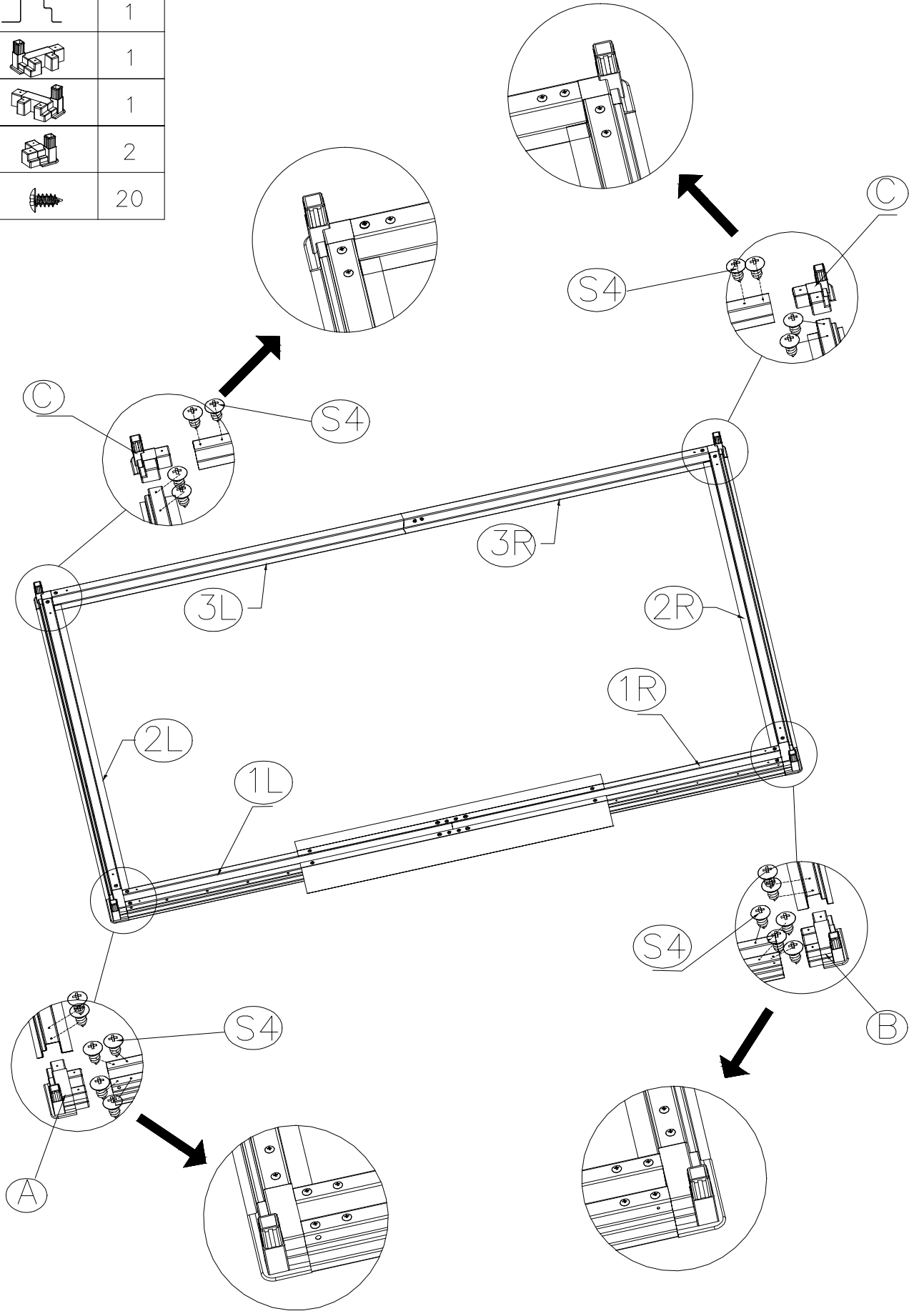

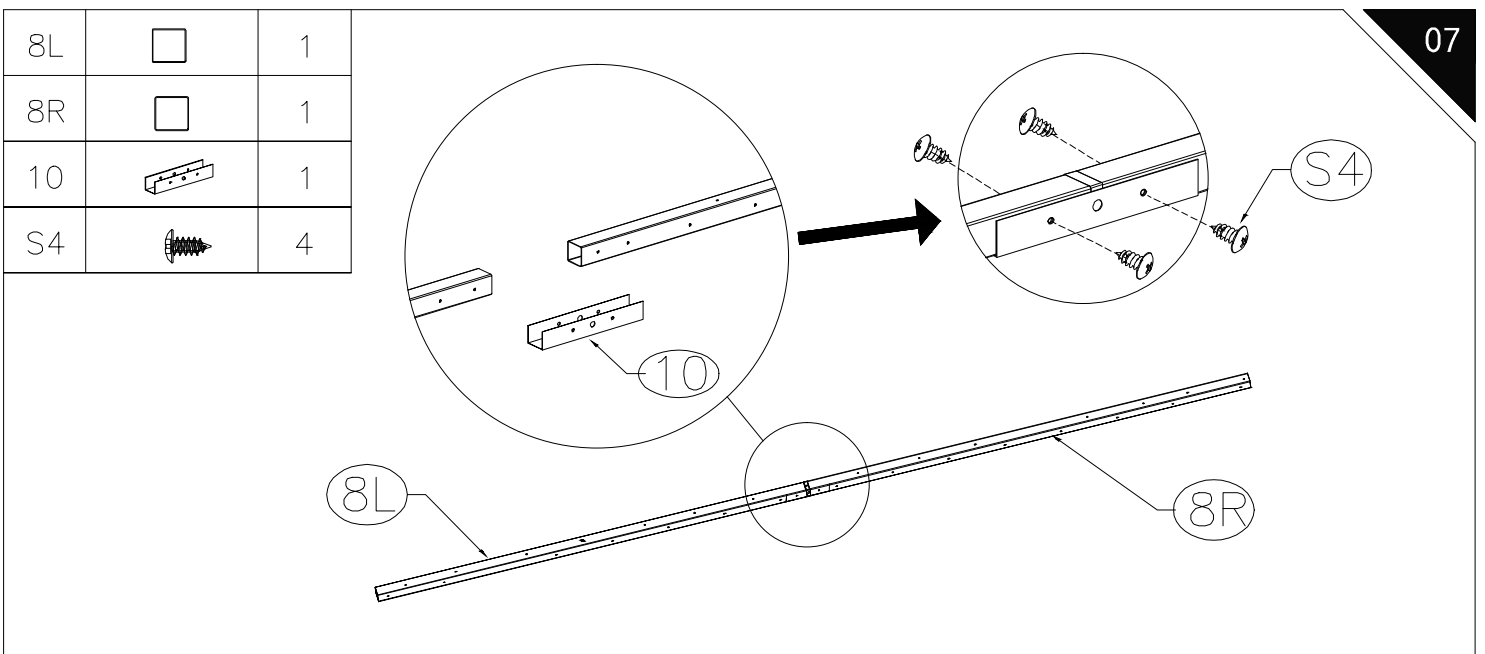
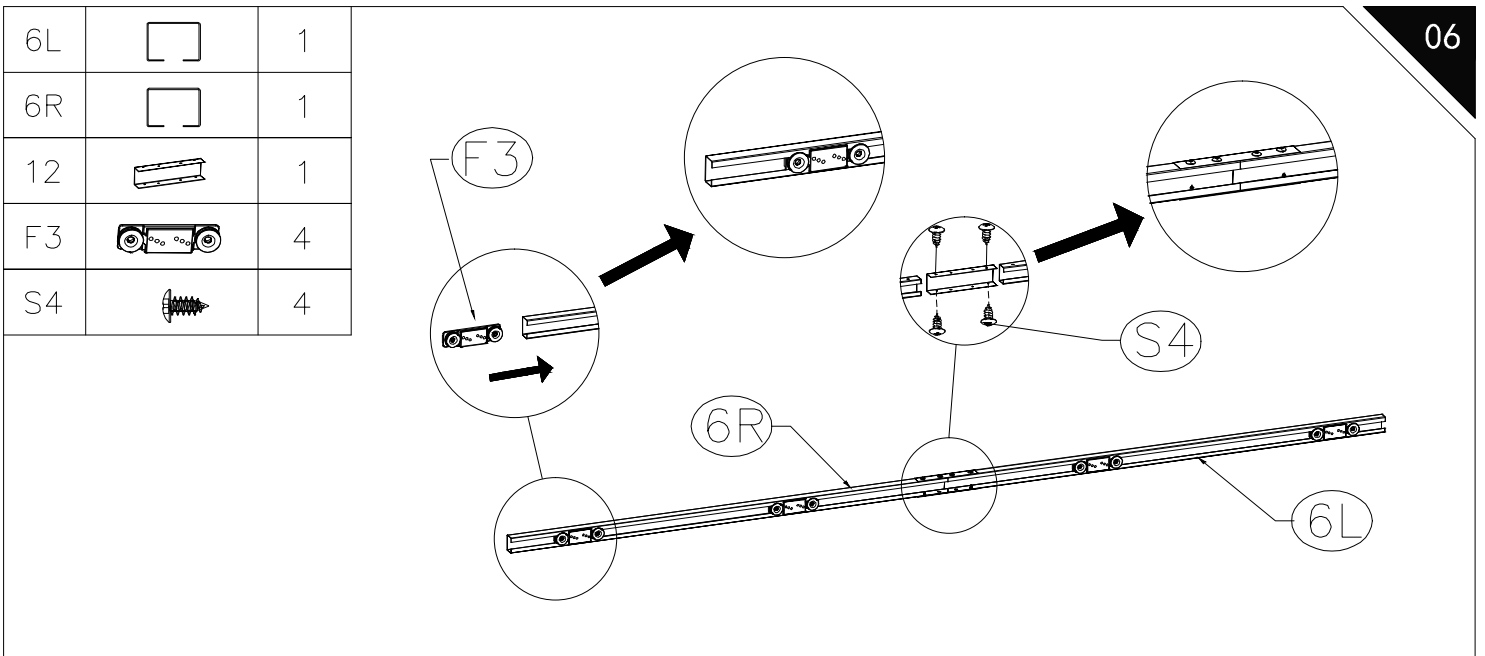
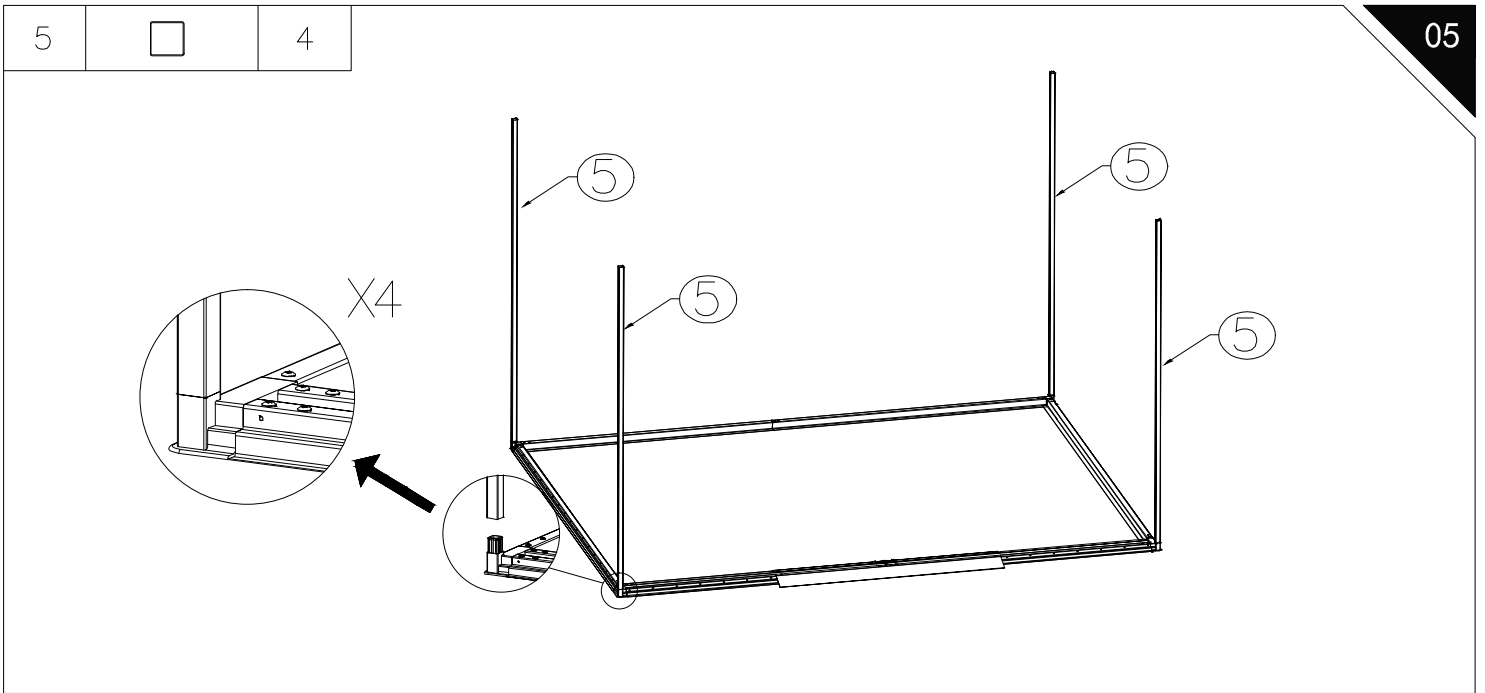

2L		1
2R		1
A		1
B		1
C		2
S4		20





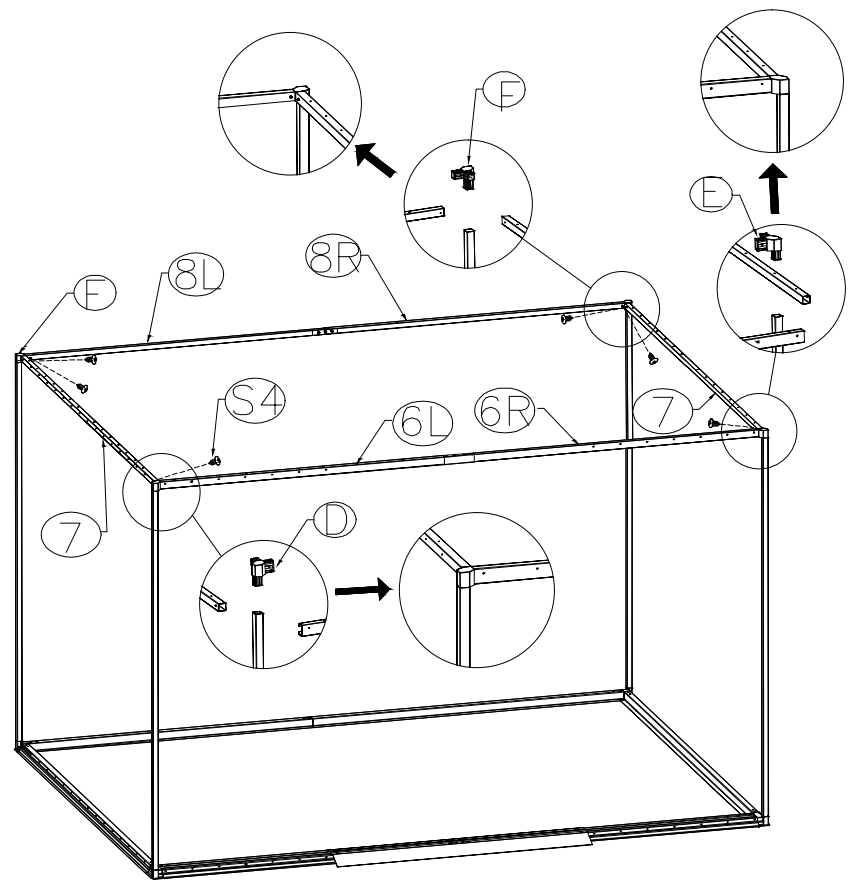



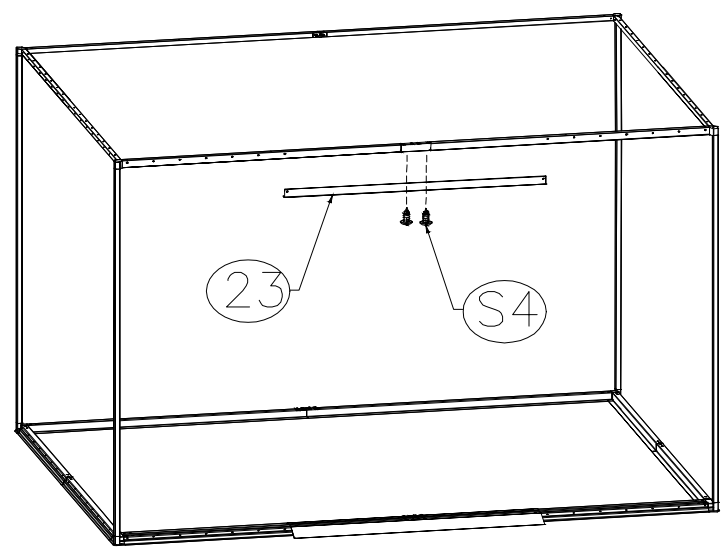

7		2
D		1
E		1
F		2
S4		6







23		1
S4		2

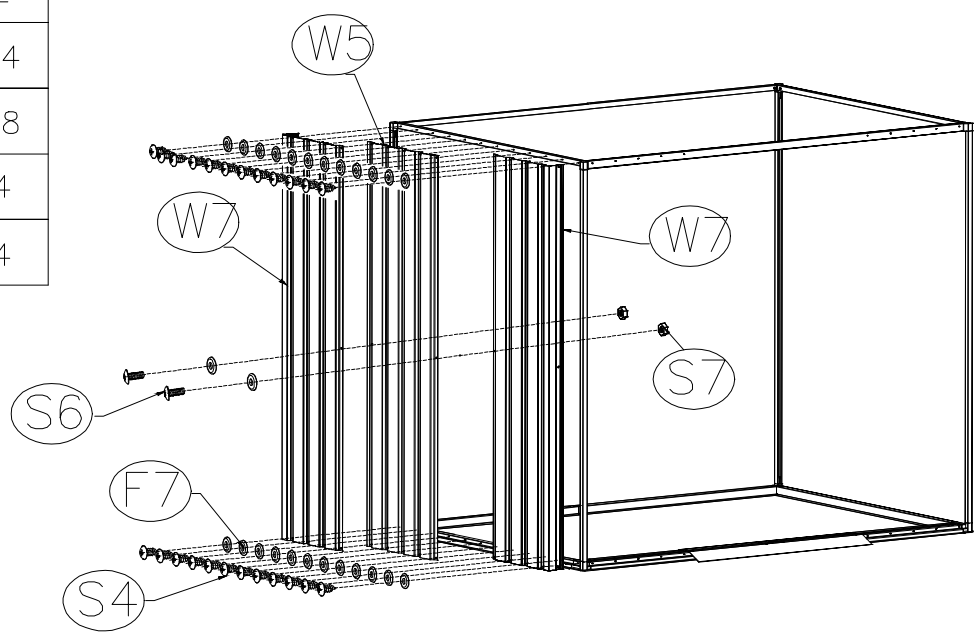







W7		4
W5		2
S4		44
F7		48
S6		4
S7		4

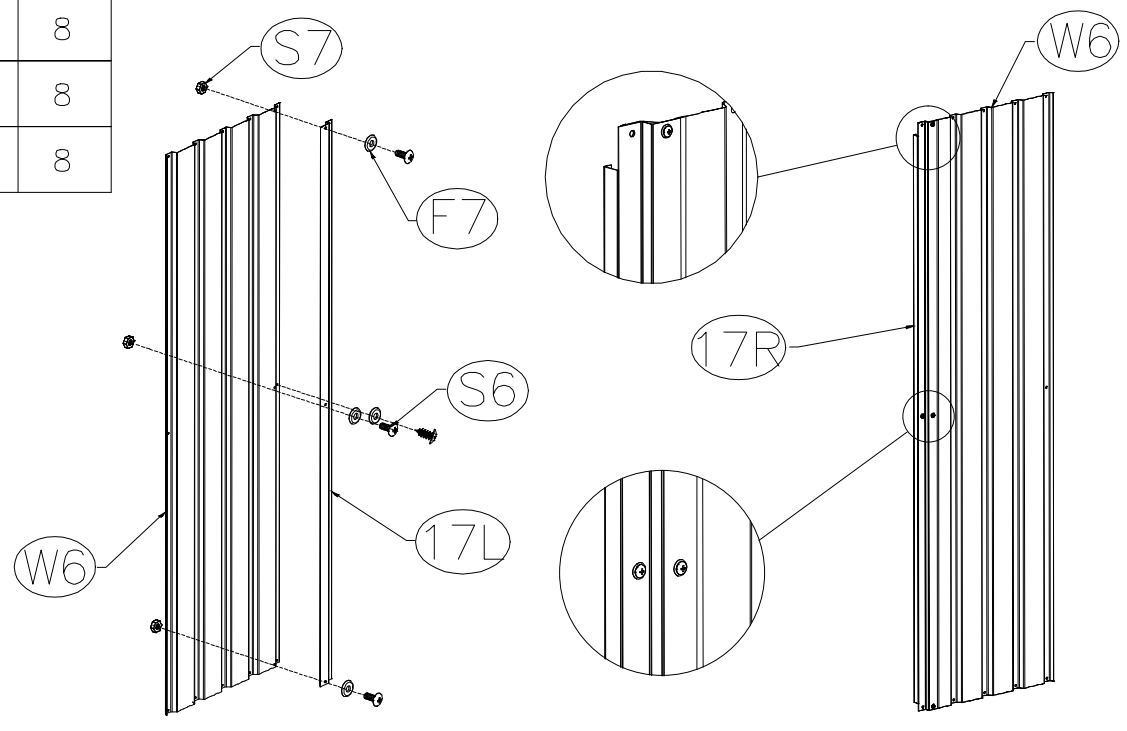





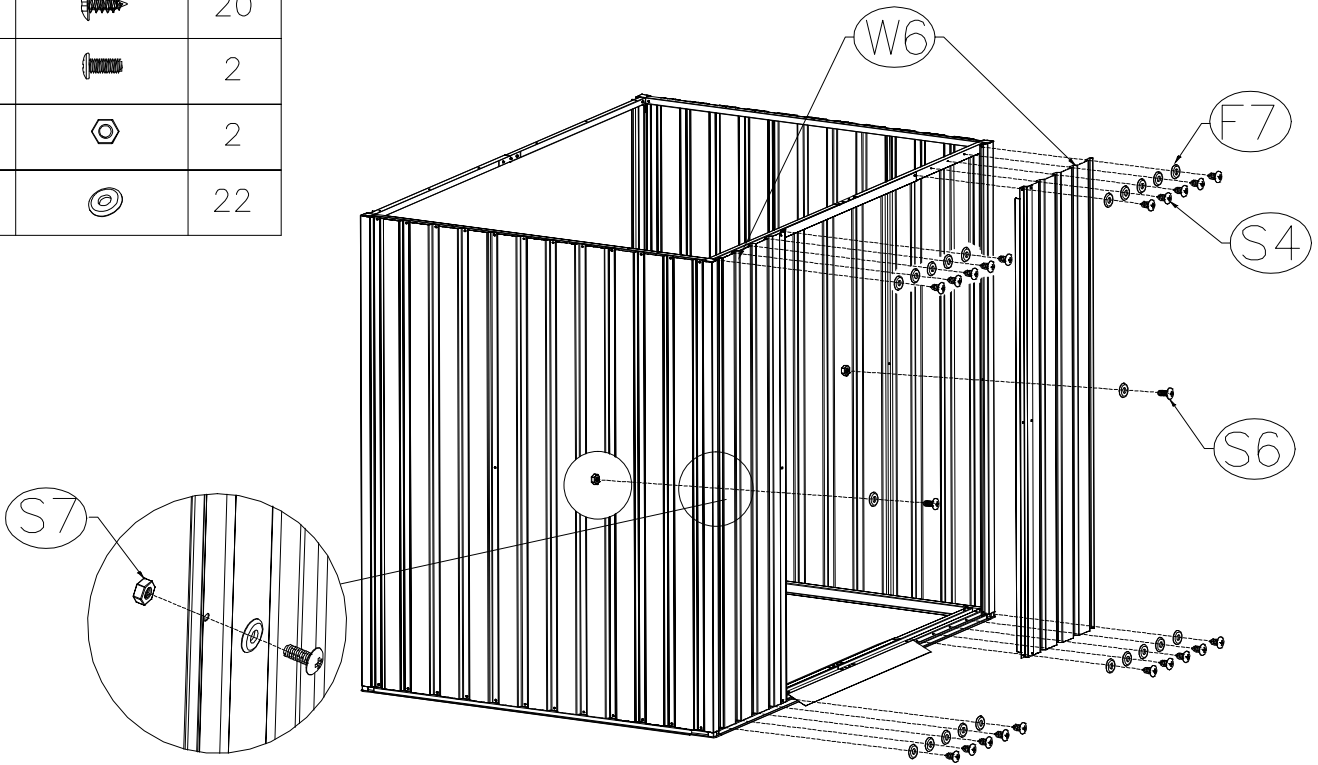

X2

17L		1
17R		1
S6		8
S7		8
F7		8







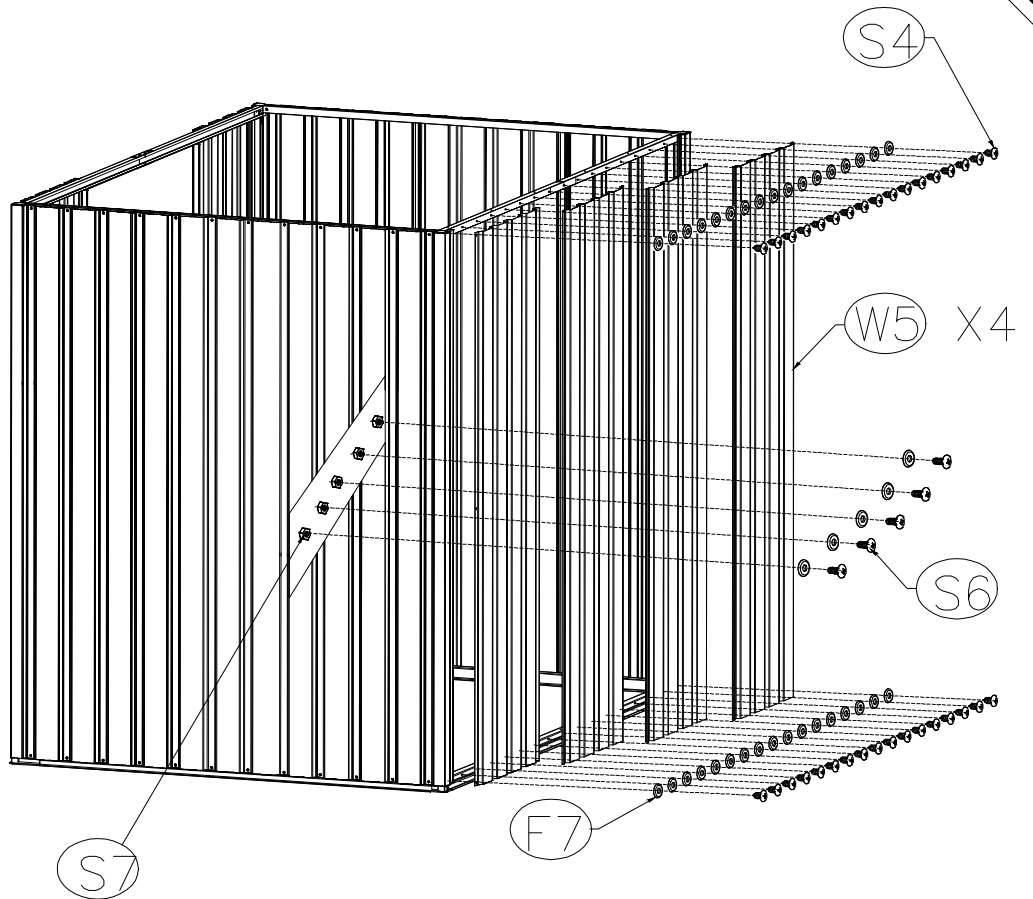

W6		2
S4		20
S6		2
S7		2
F7		22



W5		4
S4		34
S6		5
S7		5
F7		39



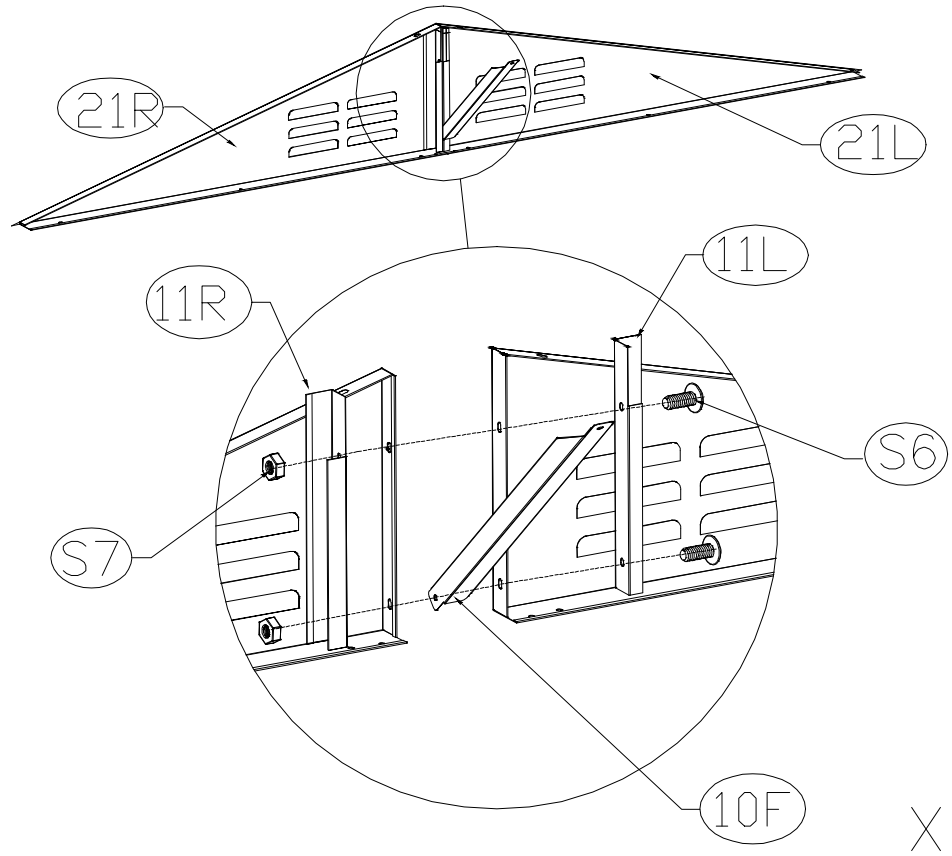

10F		2
11L		2
11R		2
21L		2
21R		2
S6		4
S7		4



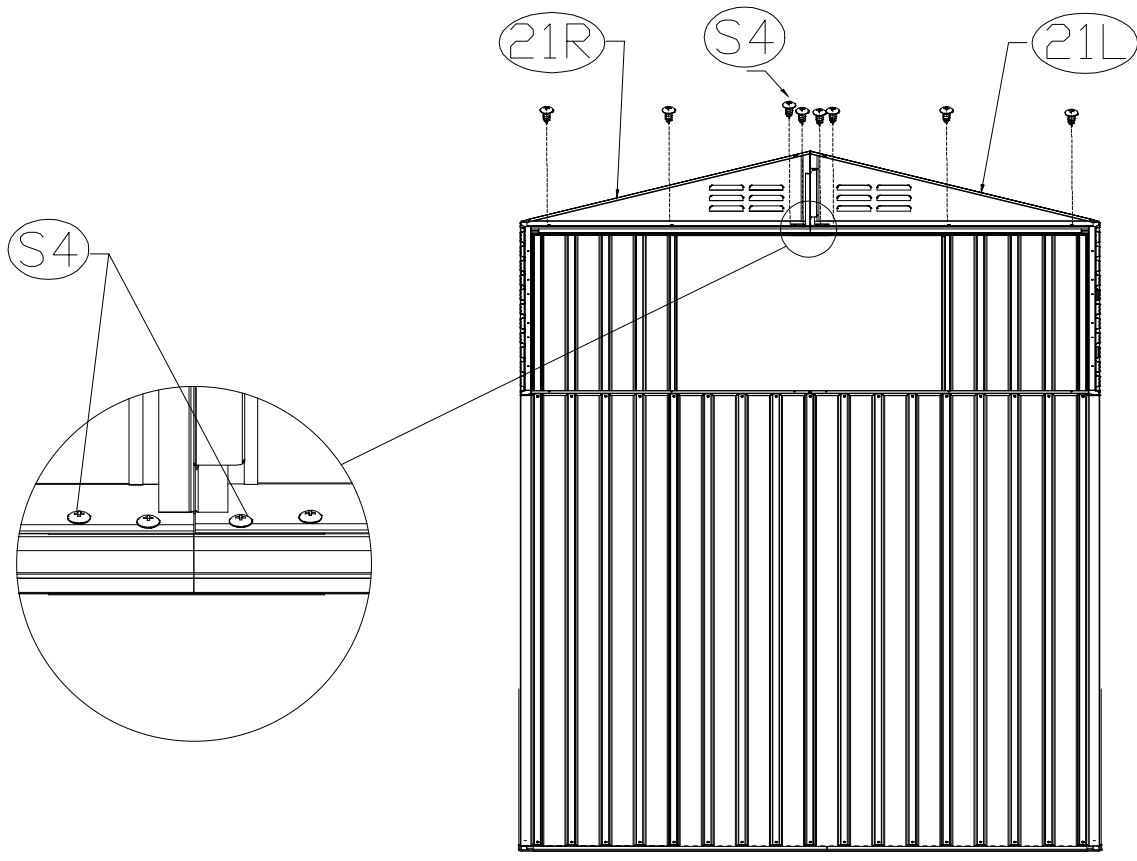

S4		16
----	---	----

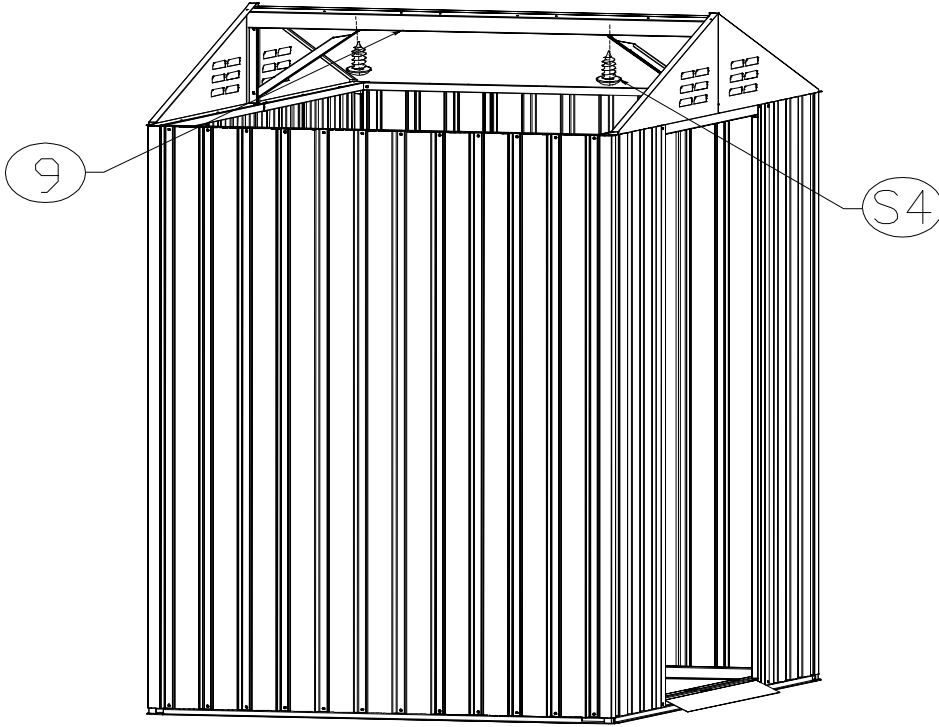

9		1
S4		2

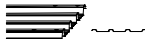

W12		8
S4		50
F7		50

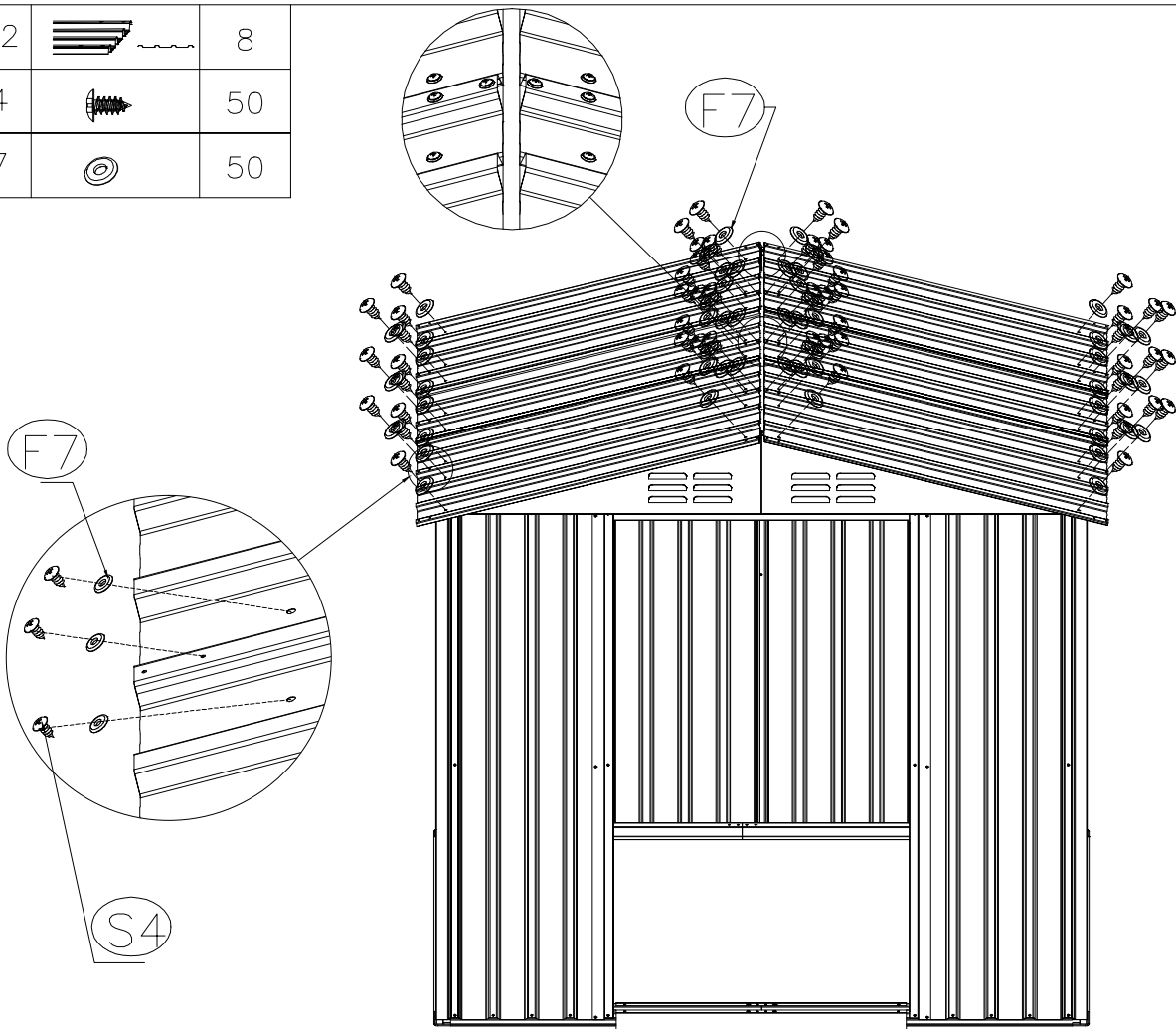

F8



16

18

F8

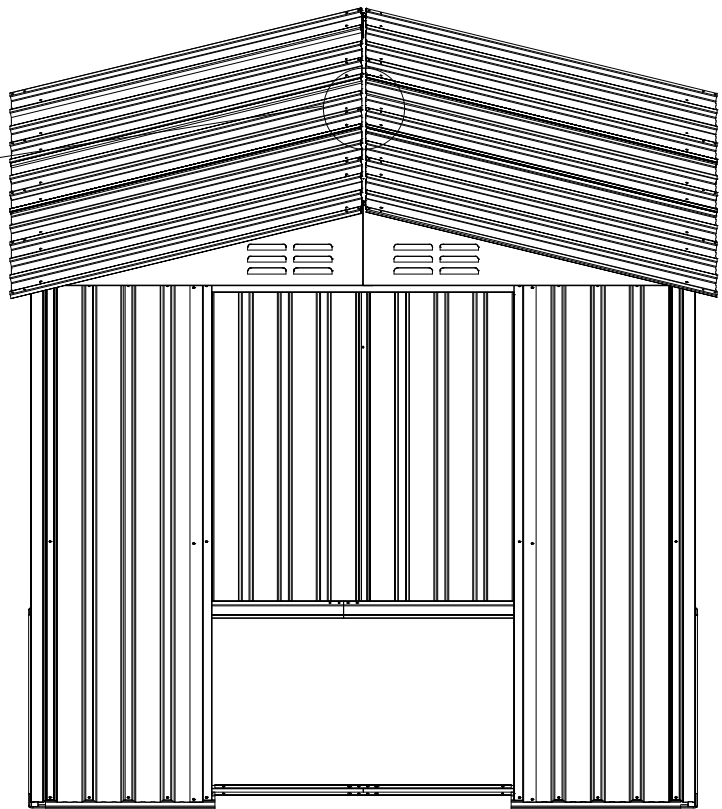
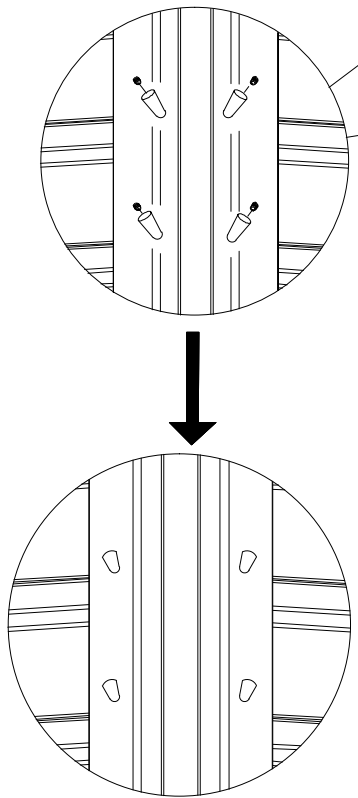

20



4

S4



8

F7



8

19

20



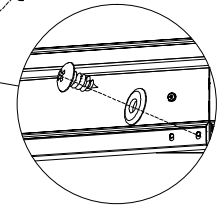
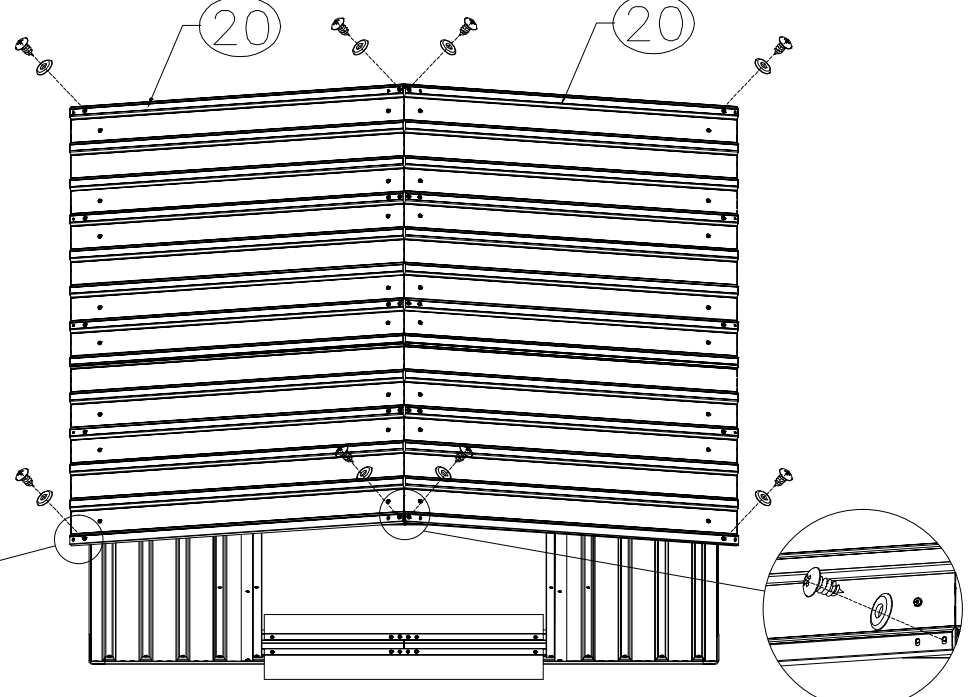
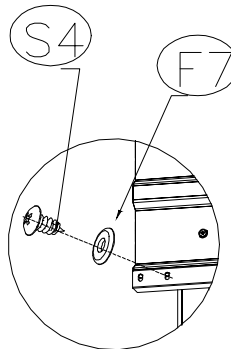

20

S4

F7



X4

19		2
F4		4
S4		6
S8		4
F7		10



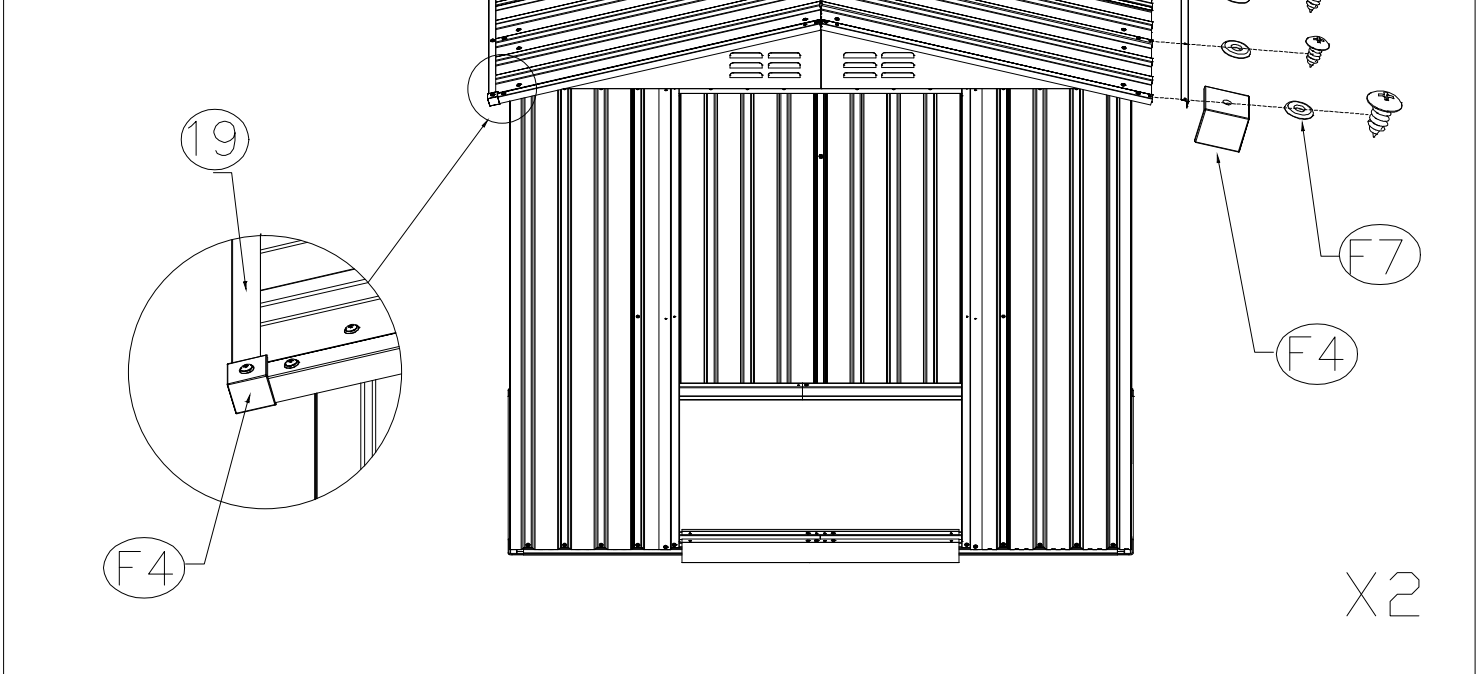



20

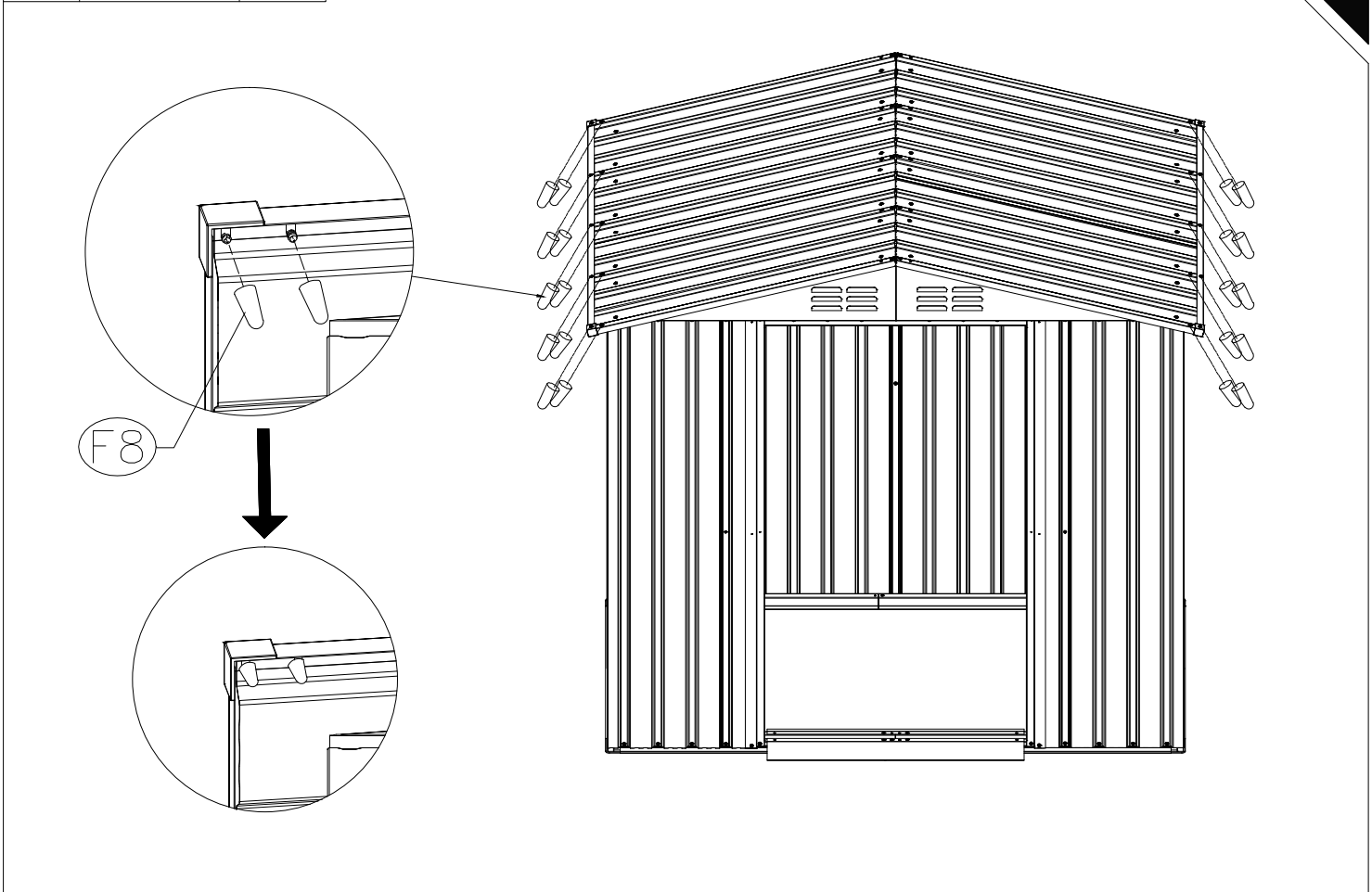

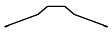
F8		20
----	---	----







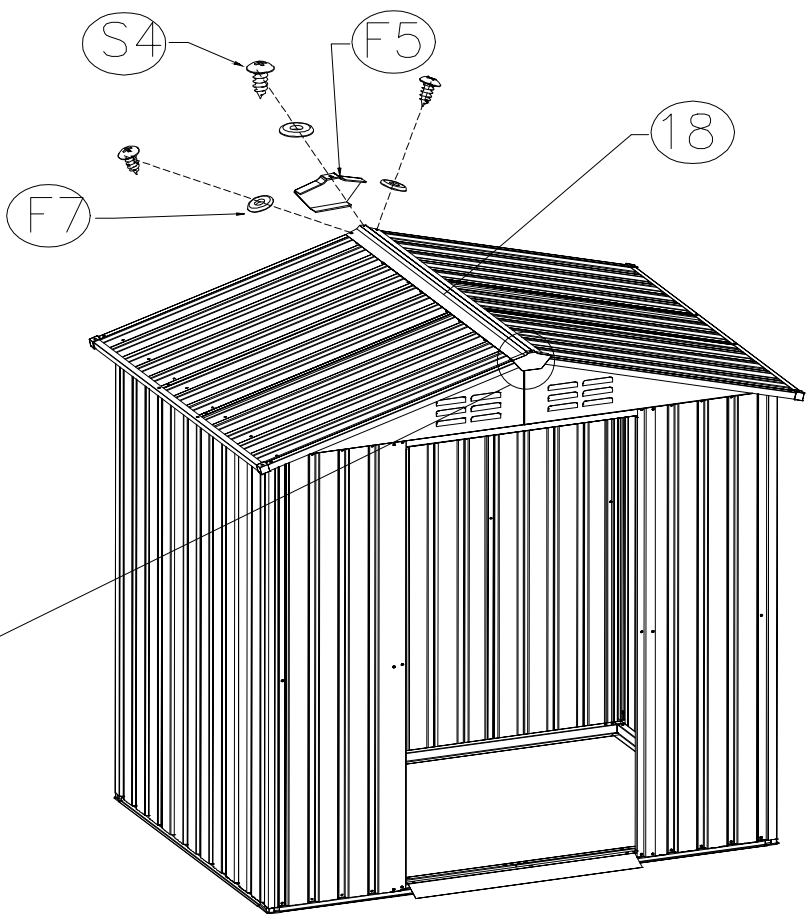

21



18		1
F5		2
S4		2
S6		4
S7		4
F7		6



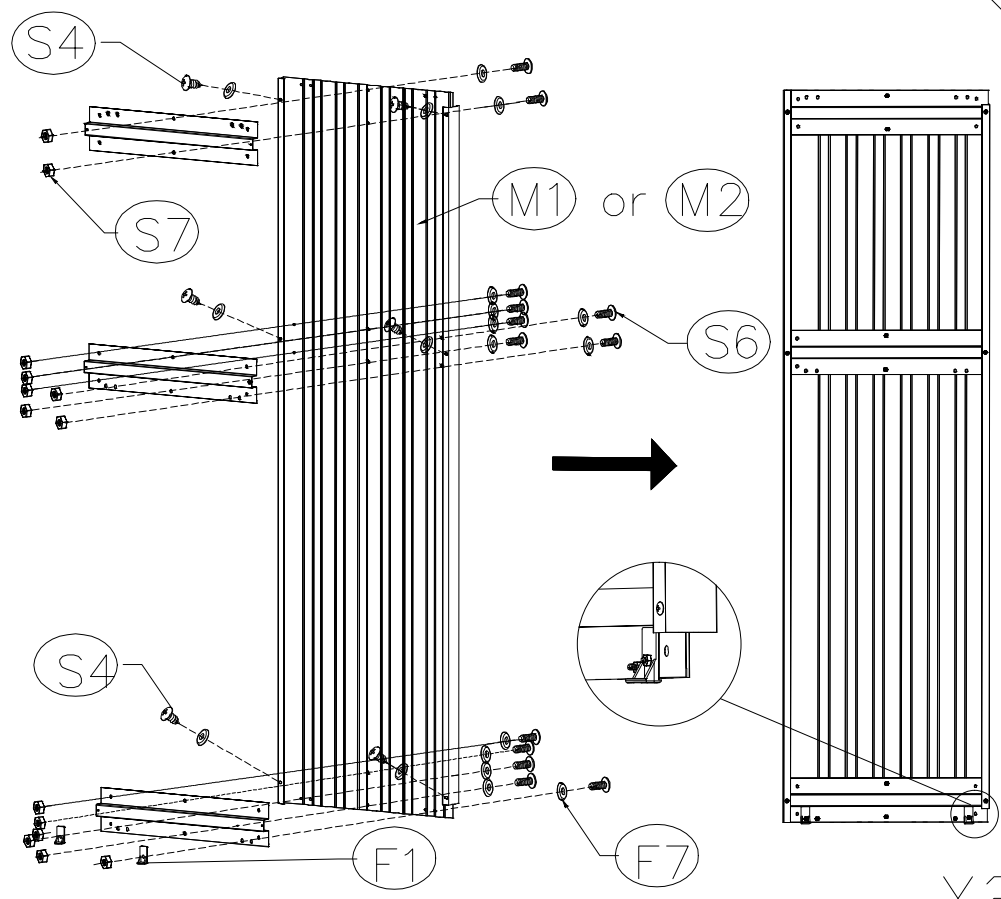

X2

M1		1
M2		1
22		6
F1		4
S4		12
S6		32
S7		32
F7		44



X2

F2		2
S6a		4
S7		4

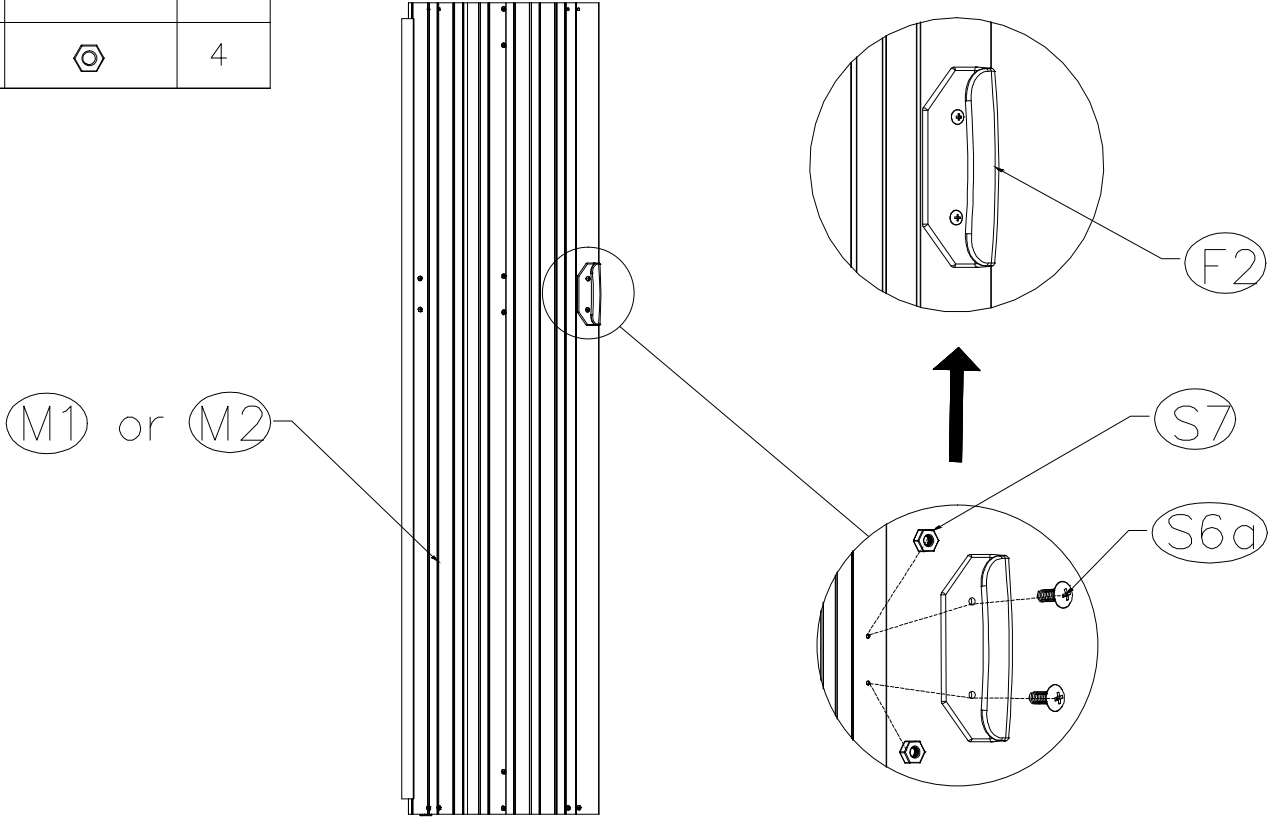

M1 or M2

F2

S7

S6a

X2

S8		8
----	---	---

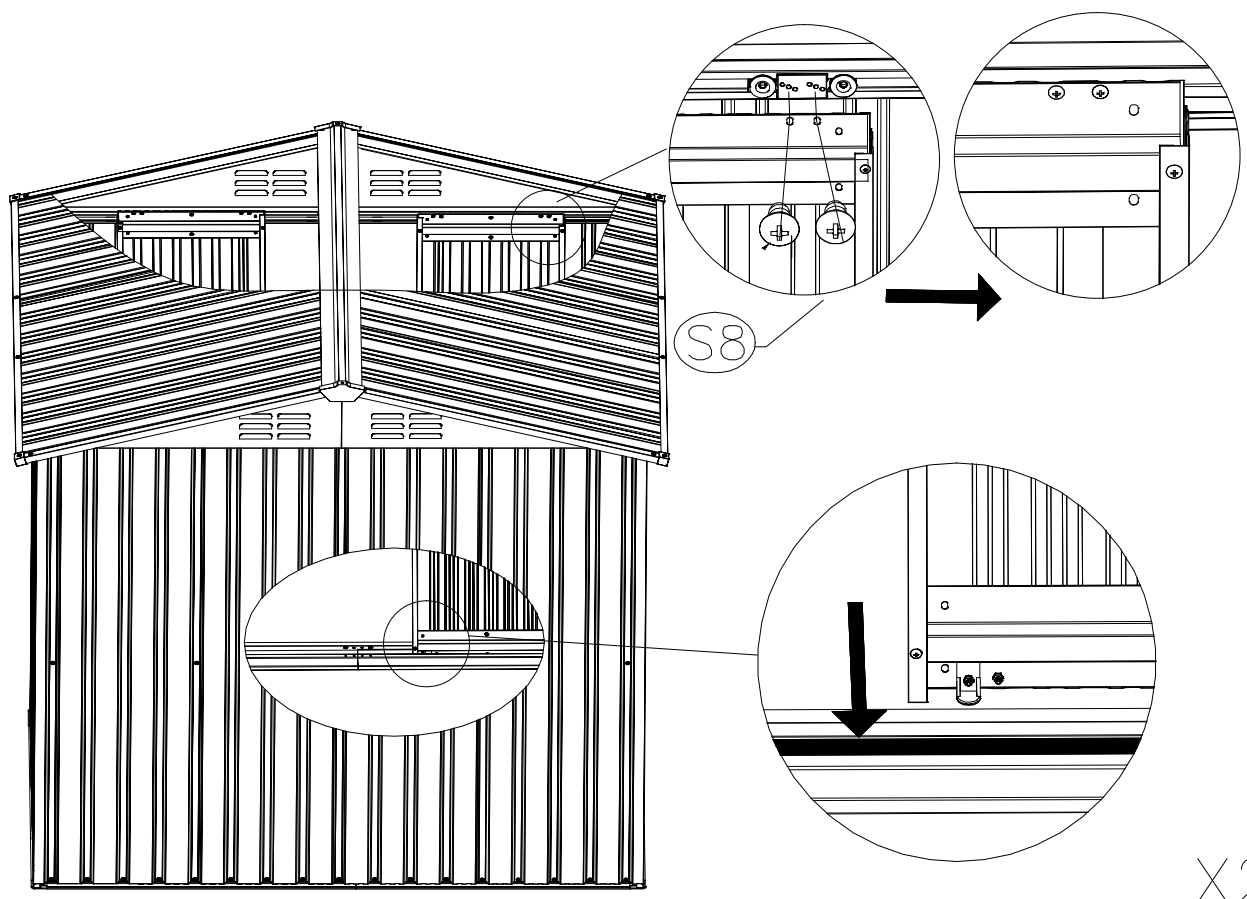

S8

X2

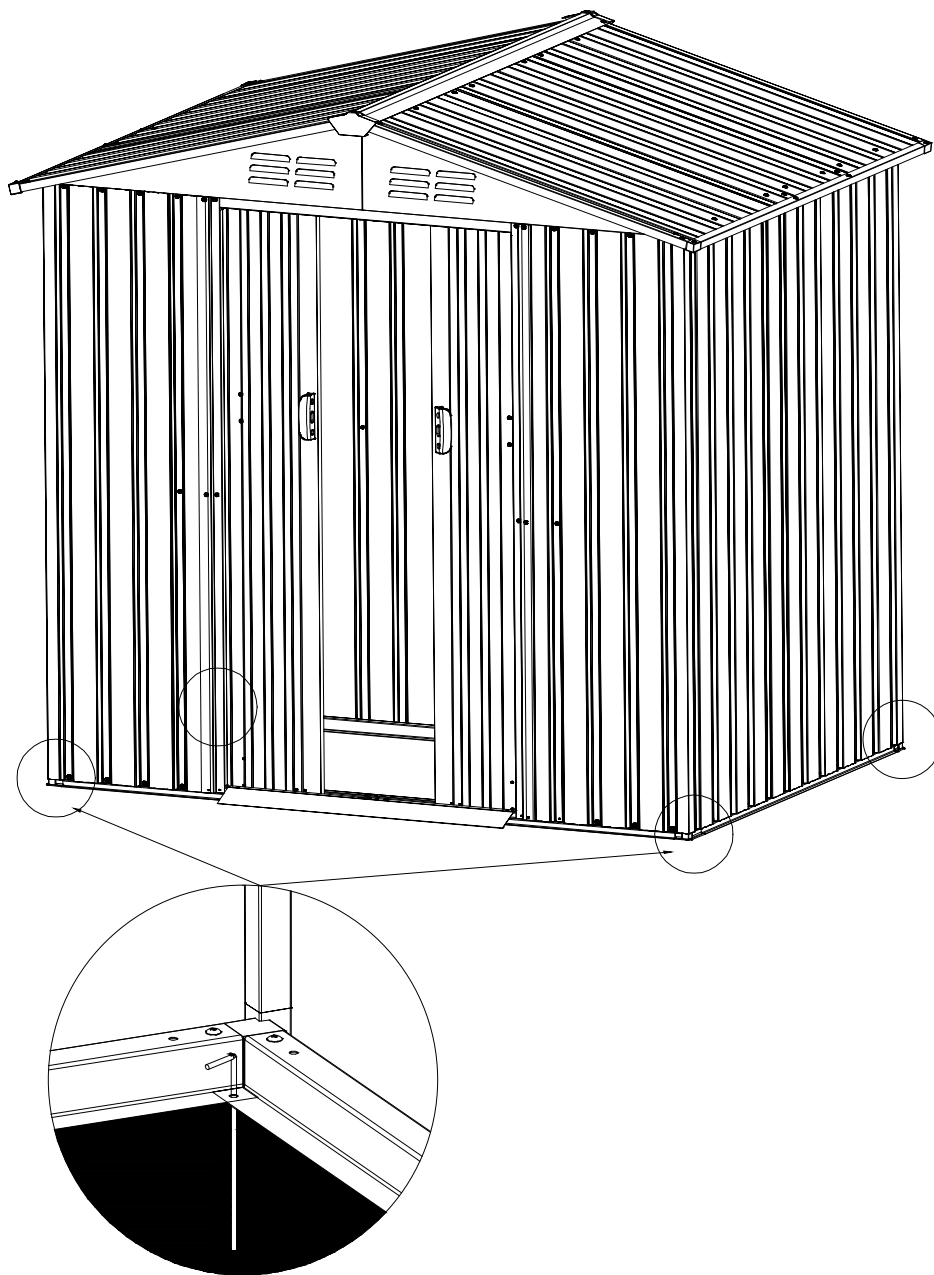

Si el cobertizo está instalado sobre césped, el [s9] se puede utilizar para aumentar su estabilidad.